

azbil

General-Purpose Self-Contained Photoelectric Sensors HP7 series

Nothing escapes his
notice, no matter what
the conditions.

Suitable for a variety of applications and conditions.

- Wide range of configurations and specifications
- Improved resistance to interference (e.g., fluorescent lights)
- Threaded metal mounting holes for more reliable installation
- Different frequency thru-scan model for stress-free installation
- Inexpensive, to meet current market needs
- Auto Adjust button for situations where detection is difficult



(To be certified in
June 2012)



(To be certified in
October 2012)

RoHs

Problem 1

- Light axis is hard to adjust over long distances (thru-scan and retroreflective models)
- Inconsistent performance with black or non-reflective objects

▶ Simple to operate and delivers reliable detection

Safe & sure Easy to use

Long-range thru-scan models have a light-operated indicator on the front, and retroreflective models send out a visible red light beam for light axis alignment over long distances. Diffuse-scan models offer the best long-distance detection standards in the industry along with consistent detection of darker colors.

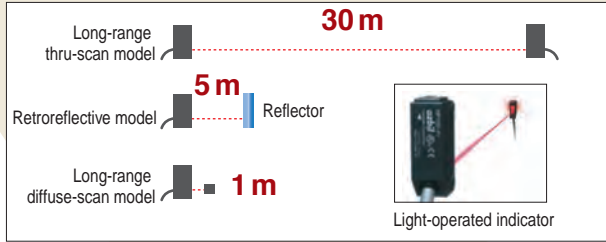

▲ Secure operating margin over a long distance

Resolves installation issues!

Problem 2

- Interference between side-by-side sensors
- Need to reverse the sensor configuration or move sensors

▶ No constraints

Safe & sure Easy to use

Thru-scan sensors using different frequencies can be installed side by side*1 without mutual interference protection filter or reversed sensor orientation. Diffuse-scan and retroreflective models are fitted with automatic interference suppression that allows two units to be used side by side.*1

*1. Subject to certain restrictions (see "Interference Suppression" in the specifications).

High-performance photoelectric sensors

Problem 4

Sensor operation affected by inverter fluorescent light

▶ Designed for modern lighting

Safe & sure Easy to use

New algorithms achieve major improvement in resistance*2 to external optical interference.



Designed for use in just about any environment!

Problem 5

Cutting oil mist near metalworking lines reduces sensor life.

▶ Improved resistance to oil

Fewer problems

Polyallylate resin lenses offer improved resistance*2 to the effects of oils and chemicals.

*2. In tests conducted by the azbil Group.

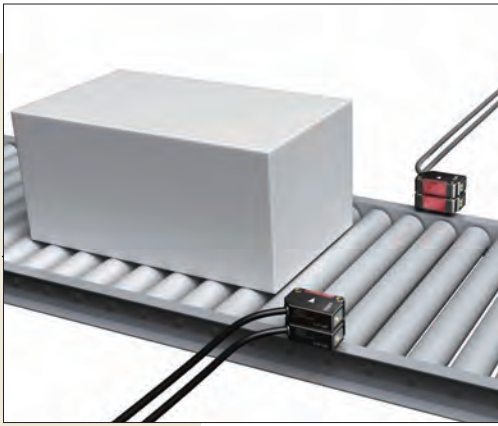

▲ Installation of thru-scan sensors using different frequencies. Multiple units can operate side by side. As previously, two diffuse-scan or retroreflective sensors can be installed side by side.

Problem³

Plastic screw holes aren't strong enough. Tightening the screws too hard or too quickly destroys the thread.

► Stronger mounting holes

Safe & sure Low cost

Threaded metal mounting holes provide improved mechanical strength.

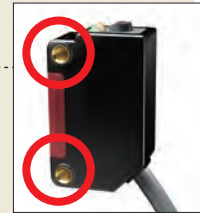

suitable for a wide range of applications

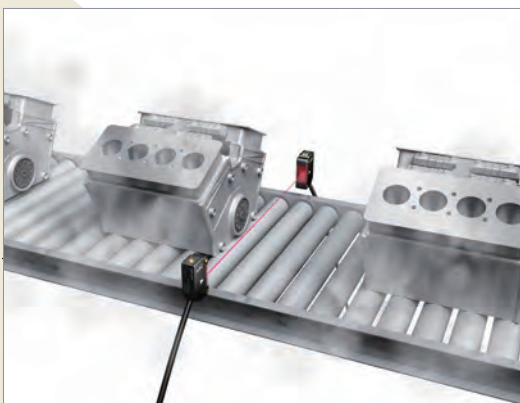

▲ Thru-scan and diffuse-scan lenses made from oil-resistant modified polyallylate

Problem⁶

Sensors don't operate in freezers at $-30\text{ }^{\circ}\text{C}$.

► Low temperature use OK

Low cost

The widest operating temperature range available today—performance in freezer environments down to $-30\text{ }^{\circ}\text{C}$ is guaranteed.



▲ Operating temperature range is -30 to $+55\text{ }^{\circ}\text{C}$

*3. Low temperature code is available as an option.

Features of the HP7 series

Sensing range and type setup

First determine the optimum detection distance, light source, and sensing width, in order to minimize adjustment during installation.

Thru-scan models

Long range: 30 m

For long-distance applications or dust-filled environments such as multilevel parking garages and automated warehouses

Standard: 15 m

For standard thru-scan sensing applications

Short distance: 4 m

For applications requiring sensitivity adjustment at distances of up to 1 m

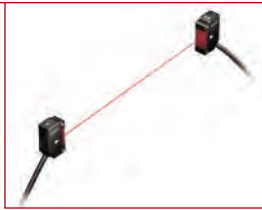

Diffuse-scan models

Infrared: 1 m

Infrared sensor with low susceptibility to color differences offering superior detection range in the industry

Red: 0.5 m

For near-distance applications requiring visual confirmation of the detected spot

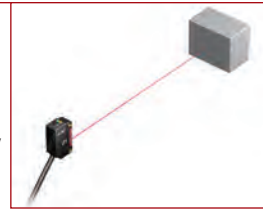

Available soon

Retroreflective models*1

Standard: 5 m

The standard type offers the longest detection range in the industry

*1. Retroreflective sensors use polarizing filters to minimize sensing error due to light reflected off a high reflective surface.

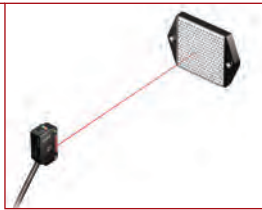

Wide beam diffuse-scan models

Wide beam: 100 mm

For applications detecting print circuit boards and inclined objects

Wide beam: 50 mm

For sensing print circuit boards while minimizing interference from surrounding areas.



Interference suppression

Using a combination of standard and different-frequency sensors (for thru scan), two sensors can be installed side by side without sacrificing space or distance.



And

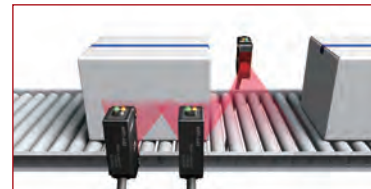
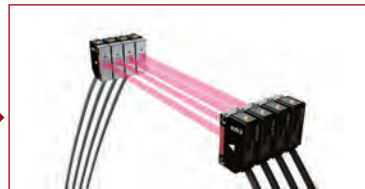

Two thru-scan sensors (red and infrared)

The combination of a standard sensor and a different frequency sensor prevents interference without installing an mutual interference protection filter or reversing the orientation of one of the units. Effective for up to two units side by side.*2

Four thru-scan sensors (red)

Using an interference mutual protection filter, it is possible to install up to four units side by side*2 without changing the orientation of any of the units.

Diffuse-scan sensor / retroreflective sensor

Automatic interference suppression allows two units to be installed in close proximity.*2

*2. Subject to certain restrictions (see "Interference Suppression" in the specifications)

Auto Adjust button

There are many situations where sensor systems can be installed using factory default settings. However in some situations, further adjustment will be required. Press the button on top of the unit to automatically adjust to the optimum sensitivity.

■ Thru-scan and retroreflective models

Inconsistent sensor operation when objects do not block the sensor beam properly

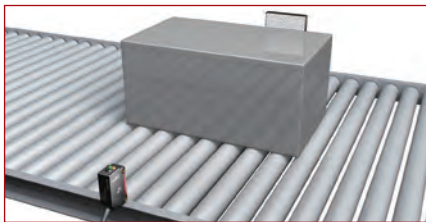

When used at factory settings, light passes through the object, affecting sensor performance.

Auto Adjust
button

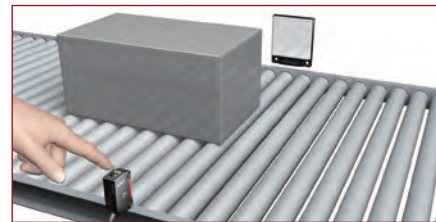

Sensor is adjusted to appropriate sensitivity.

■ Diffuse-scan models

Sensor operation affected by background



At the factory default setting, the sensor is constantly triggered by background.

Auto Adjust
button



Sensor is adjusted to appropriate sensitivity.

High-intensity red LED

Due to high-intensity four-element LED, light spot is easy to be recognized, helping to save time during light axis adjustment.



Excellent resistance to sunlight

Sensors are designed to provide a high level of resistance to sunlight (an industry-leading 40,000 lx) .



How to use the Auto Adjust button

If sensor operation is not consistent at factory default settings, press the Auto Adjust button to adjust sensitivity automatically.

Tuning without a workpiece

In certain applications involving thru-scan and retroreflective sensors, the target may not block the sensor beam properly due to unwanted reflection and/or permeation of light. In some cases, diffuse-scan sensors may erroneously recognize background as the target. Tuning without a workpiece is the first step in trying to resolve the problem. Tuning without a workpiece refers to tuning with no target object present.

- Thru-scan and retroreflective sensors: Automatically adjusts sensitivity to trigger the sensor at approximately half the intensity of the light received when there is no target object present.
- Diffuse-scan sensor: Automatically adjusts sensitivity to trigger the sensor at approximately twice the intensity of the light received when there is no target object present.

Sensor is triggered by background

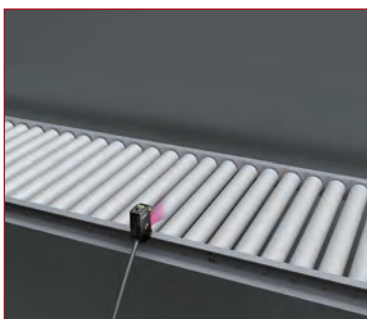

Erroneously detects background as the target when operated at factory default settings (maximum sensitivity).



Tune without a workpiece. Background information is suppressed.

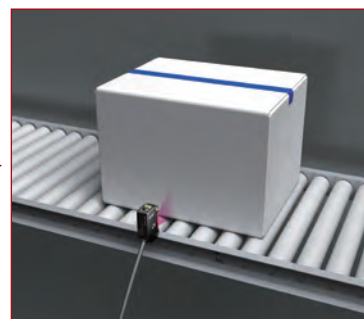

Cardboard boxes are now detected consistently and reliably.

Light seeps through semi-transparent target object



Light passes through semi-transparent target objects, affecting detection consistency.



Tune without a target object.



Target is now detected correctly.
Note: Highly transparent objects cannot be detected. Check with actual target objects before running a machine.

Unwanted reflections affect detection consistency

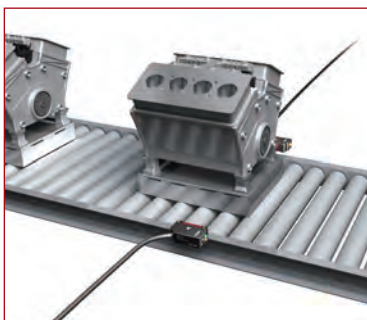

Reflected light passes through gaps in the target object, causing detection errors.

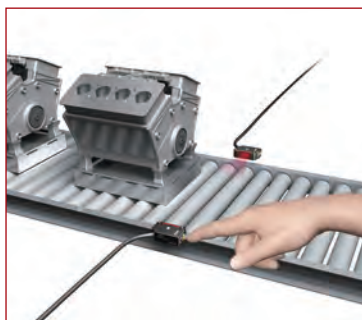

Tune without a target object.

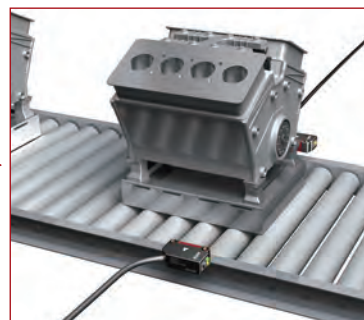

Palettes are now detected correctly.

Two-point tuning

Two-point tuning is used in situations where tuning without a workpiece does not achieve the required results, or where it is necessary to detect target objects at a specific location. Sensitivity is automatically set to a value mid-way between the state when the target is present and when the target is absent.

False detection

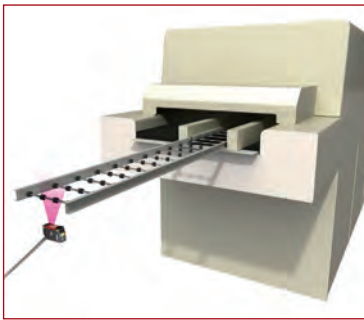

The sensor detects background objects such as the conveyor.

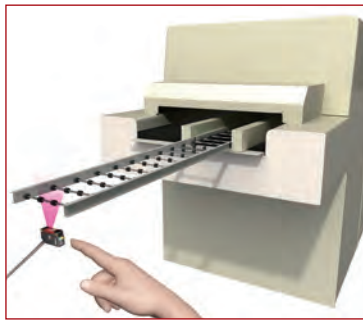

First, the sensor is exposed to the no-target state.

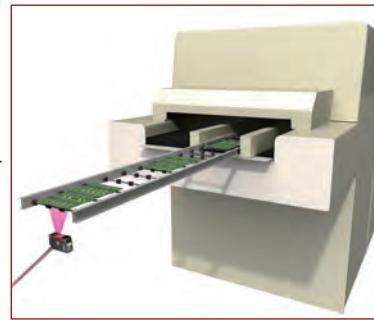

Next, the sensor is exposed to the state with a target present. The sensor is now able to distinguish between the two states.

Detection in a specific position

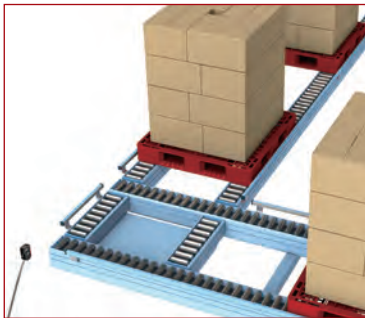

The aim is to sense the target object as it reaches the designated position.

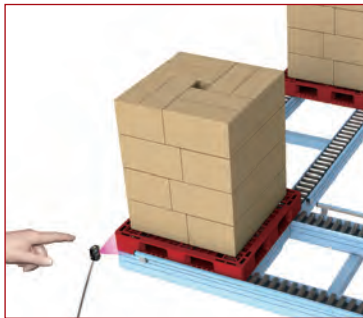

Position tuning is performed at the required position.

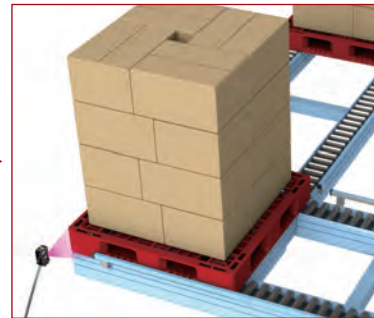

The sensor operates around at this position. Note that the sensing distance can vary by as much as 15% from the set distance.

Catalog listings

■ Base model number

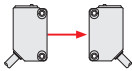
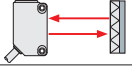
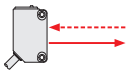
Detection method / Configuration	Detection range & light source	Catalog listing	Out put	Wiring method	
Thru-scan 	30m/Infrared	HP7-T41	NPN	cable	2m
		HP7-T42	PNP	cable	2m
	15m/Red	HP7-T11	NPN	cable	2m
		HP7-T12	PNP	cable	2m
	15m/Infrared	HP7-T21	NPN	cable	2m
		HP7-T22	PNP	cable	2m
	4m/Red	HP7-T51	NPN	cable	2m
		HP7-T52	PNP	cable	2m
Retroreflective 	5m/Red	HP7-P11	NPN	cable	2m
		HP7-P12	PNP	cable	2m
Diffuse-scan 	1m/Infrared	HP7-A43	NPN	cable	2m
		HP7-A44	PNP	cable	2m
	0.5m/Red	HP7-A13	NPN	cable	2m
		HP7-A14	PNP	cable	2m
Wide-beam diffuse scan Available soon	100mm/Infrared	HP7-D23	NPN	cable	2m
		HP7-D24	PNP	cable	2m
	50mm/Infrared	HP7-D63	NPN	cable	2m
		HP7-D64	PNP	cable	2m

HP7- T__ Thru-scan: Emitter model number is HP7-E__ and receiver model number is HP7-R__.

■ Thru-scan sensors different frequencies















Combination model	Detection range & light source	Catalog listing	Out put	Wiring method	
HP7-T41 type	30m Infrared	HP7-T45	NPN	cable	2m
HP7-T42 type		HP7-T46	PNP	cable	2m
HP7-T11 type	15m Red	HP7-T15	NPN	cable	2m
HP7-T12 type		HP7-T16	PNP	cable	2m
HP7-T21 type	15m Infrared	HP7-T25	NPN	cable	2m
HP7-T22 type		HP7-T26	PNP	cable	2m
HP7-T51 type	4m Red	HP7-T55	NPN	cable	2m
HP7-T52 type		HP7-T56	PNP	cable	2m

■ Connection options

Type	ConfigurationBase model number	Catalog listing	HP7-P11-L050	HP7-P11-C003	HP7-P11-S003	HP7-P11-T
		Connection type	5 m cable	M12 prelead ² connector	Quick Lock ^{1,2}	M8 connector
		Base model number	Base model number-L050	Base model number-C003	Base model number-S003	Base model number-T
Thru-scan	30m Infrared	HP7-T41	✓	✓	-	-
		HP7-T42	✓	✓	-	-
	15m Red	HP7-T11	⊙	⊙	✓	✓
		HP7-T12	⊙	✓	✓	✓
	15m Infrared	HP7-T21	✓	-	-	-
		HP7-T22	✓	-	-	-
	4m Red	HP7-T51	✓	✓	-	-
		HP7-T52	✓	✓	-	-
Retroreflective	5m Red	HP7-P11	⊙	⊙	✓	✓
		HP7-P12	✓	✓	✓	✓
Diffuse-scan	1m Infrared	HP7-A43	✓	✓	✓	✓
		HP7-A44	✓	✓	✓	✓
	0.5m Red	HP7-A13	✓	✓	✓	✓
		HP7-A14	✓	✓	✓	✓
Thru-scan sensors, different frequencies	30 m Infrared sensors, different frequencies	HP7-T45	✓	-	-	-
		HP7-T46	✓	-	-	-
	15 m Red sensors, different frequencies	HP7-T15	✓	✓	✓	✓
		HP7-T16	✓	✓	✓	✓
	15 m Infrared sensors, different frequencies	HP7-T25	✓	-	-	-
		HP7-T26	✓	-	-	-
	4 m Red sensors, different frequencies	HP7-T55	✓	-	-	-
		HP7-T56	✓	-	-	-

✓ : available ⊙ : Always in stock; for other products, ask for delivery time.
 *1. Interchangeable with Omron Smart Click. *2. Cord length is 300 mm.

■ Accessories

Name	Configuration	Description	Catalog listing	Compatible model
Reflector for retroreflective model		Reflector size 47 x 47 mm	FE-RR22 (Scanning distance 0.05 to 5 m)	HP7-P_
		Reflector size 30.8 x 30.8 mm	FE-RR18 (Scanning distance 0.05 to 3.3 m)	HP7-P_
		Reflector size 37 x 56 mm	FE-RR21 Scanning distance: horiz. mounting 0.05 to 5 m, vertical mounting 0.05 to 4.8 m*2	HP7-P_
		Reflector size 47 x 47 mm	FE-RR8 (Scanning distance 0.05 to 5 m)	HP7-P_
		Reflector size 30.8 x 30.8 mm	FE-RR15 (Scanning distance 0.05 to 3.3 m)	HP7-P_
		Reflector size 8.6 x 29.5 mm	FE-RR20 Scanning distance: horiz. mounting 0.05 to 1.8m, vertical mounting 0.05 to 1.3 m*2	HP7-P_
Standard bracket		Bottom-mounting L-bracket	HP-B08	All models
		Bottom-mounting L-bracket	HP-B09	All models
		Rear-mounting L-bracket	HP-B10	All models
Wraparound mounting bracket		Wraparound vertical mounting bracket	HP-B11	All models
		Wraparound horizontal mounting bracket	HP-B12	All models
Slit for thru-scan model		Vertical slit	HP-SV05 HP-SV10 HP-SV20	HP7-T_
		Horizontal slit	HP-SH05 HP-SH10 HP-SH20	HP7-T_
Mutual interference protection filter for thru-scan model		Mutual interference can be prevented by changing the polarizing direction of 2 adjacent emitter-receiver pairs	HP-U02	HP7-T1_/T5_

*2 horiz. mounting

vertical mounting



Specification

Catalog listing	NPN	HP7-P11	HP7-T51	HP7-T11(Infrared) HP7-T21(Red)	HP7-T41	HP7-A13	HP7-A43
	PNP	HP7-P12	HP7-T52	HP7-T12(Infrared) HP7-T22(Red)	HP7-T42	HP7-A14	HP7-A44
Detection method	Retroreflective*2		Thru-scan			Diffuse-scan	
Power supply	10.2 to 26.4V DC (ripple 10% max.)						
Power consumption	14 mA max.	22 mA max.	25 mA max. (Infrared) 30 mA max. (Red)	32 mA max.	14 mA	17 mA	
Scanning distance	5 m (with FE-RR8 reflector)	4 m	15 m	30 m	0.5 m	1 m	
Target object	Opaque object 80 mm dia. min (with FE-RR8 reflector)	Opaque object 12 mm dia. min.			Standard target object: 200 × 200 mm paper, 90 % reflectivity		
Differential travel	-	-			20% max. (at rated scanning distance)		
Operation mode	Light-operate / Dark-operate selectable by operation button						
Output mode*1	NPN or PNP open collector						
Control output	Switching current: 100 mA (resistive load). Output dielectric strength: 30V. Voltage drop: 3V max. (at 100 mA switching current). 1.1V max. (less than 10mA).						
Response time	1msec	1 ms (different frequency model: 3 ms)				1msec	
Light source	Red, 4 elements (wavelength approx. 645 nm)	Red, 4 elements (wavelength approx. 645 nm)	Red, 4 elements (wavelength approx. 645 nm) Infrared (wavelength approx. 860 nm)	Infrared (wavelength approx. 860 nm)	Red, 4 elements (wavelength approx. 645 nm)	Infrared (wavelength approx. 860 nm)	
Scanning angle	0.5 to 10°	2 to 20°			-		
Indicator	Output ON: orange indicator ON at stable light and stable dark: green indicator Thru-scan emitter: power indicator 30 m thru-scan receiver: light-operated indicator on front						
Ambient light immunity	Incandescent lamp: 10,000 lux max. Sunlight: 40,000 lux max. HP7-T_-, HP7-P_-: Minimum angle of incidence of surrounding light = 5° HP7-A_-: Minimum angle of incidence of surrounding light = 15°						
Operating temperature	-30 to +55°C (without freezing or condensation) *6						
Operating humidity	35 to 85% RH (without freezing or condensation)						
Storage temperature	-40 to +70°C (without freezing or condensation)						
Insulation resistance	20MΩ min. (at 500Vdc)						
Dielectric strength	1,000Vac 50/60Hz for one minute between electrically live metal and case						
Vibration resistance	10 to 55Hz, 1.5 mm peak-to-peak amplitude, 2 hours each in X, Y, and Z directions						
Shock resistance	500m/s ² 10 times each in X, Y and Z directions						
Sensitivity adjustment	Operation button						
Protective structure	IP67 (IEC standard)						
Wiring method	HP7-_-_: prelead 2 m, HP7-_-L050 prelead 5 m, HP7-_-C003: M12 prelead connector 30 cm, HP7-_-T: M8 prelead connector						
Circuit protection	Error prevention circuit at power on (max. 60 ms) Full wiring error protection						
Interference suppression*5	Up to two diffuse-scan and retroreflective sensors, or two thru-scan sensors when operating at different frequencies or using mutual interference protection filters*4 (red), or up to four thru-scan sensors when using different frequencies together with mutual interference protection filters (red)						

*1. An FET is used for output

*2. Retroreflective sensors feature polarizing filters; however, performance may be affected by highly reflective objects and objects that interfere with polarization.

*3. Response time may be longer if affected by light from other sensors.

*4. Mutual interference protection filters are for red light source.

*5. Interference suppression used in combination with different frequencies on thru-scan sensors is effective under the following conditions. Avoid head-on detection with close contacted mounting of diffuse-scan sensors.

Catalog listing	HP7-T5_	HP7-T1_/HP7-T2_	HP7-T4_	HP7-T1_ + HP-U02
Set distance	1.3 m max.	5 m max.	10 m max.	2 m max.
Sensitivity setting	Maximum sensitivity (with light axis adjustment)			

*6. Standard cord might get hardened under 0°C. Low temperature cord is available as an option.

Output circuit diagram (Note that a FET is used for output)

Thru-scan emitter

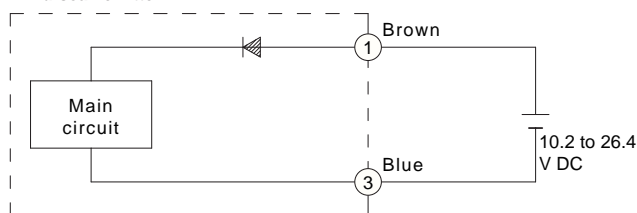

(NPN output type)

Polarized retroreflector model, Thru-scan receiver, Diffuse-scan mode

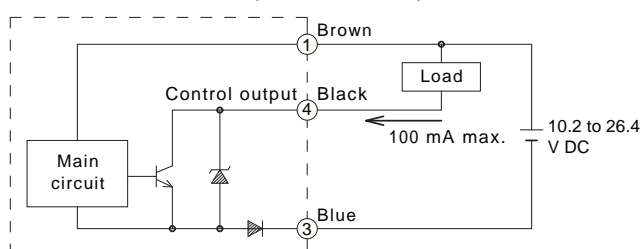

(PNP output type)

Polarized retroreflector model, Thru-scan receiver, Diffuse-scan mode

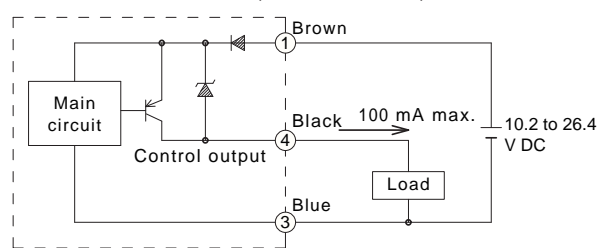

Characteristics diagrams (typical examples)

Thru-scan models (HP7-T1_/T2_/T5_)

Excess gain

(light received over the required amount)

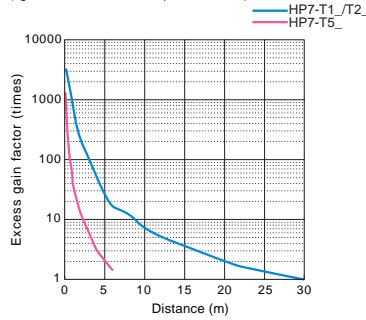

Excess gain

HP7-T4_

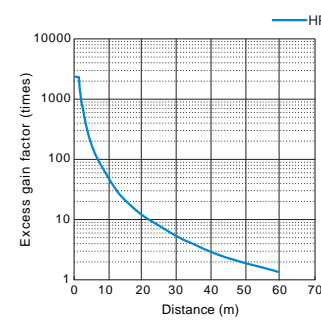

Excess gain

(light received over the required amount)

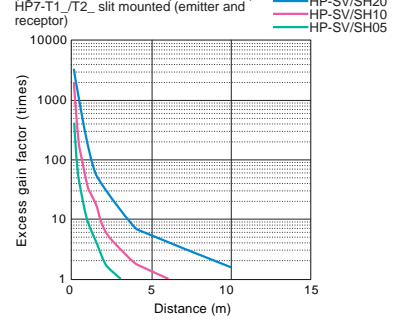

Excess gain

(light received over the required amount)

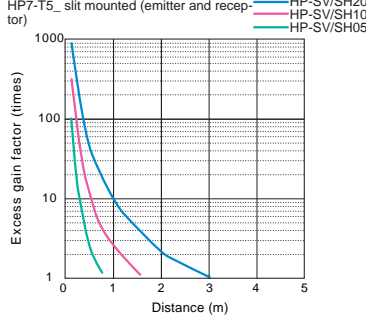

Excess gain

(light received over the required amount)

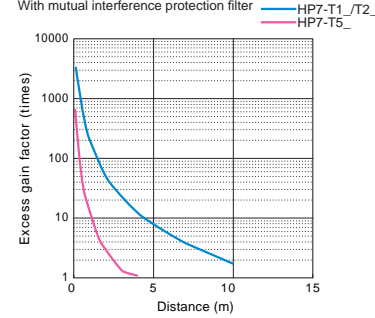

Parallel displacement

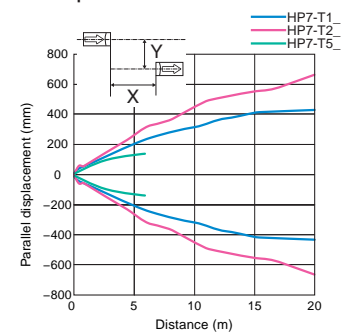

Parallel displacement

HP7-T4_

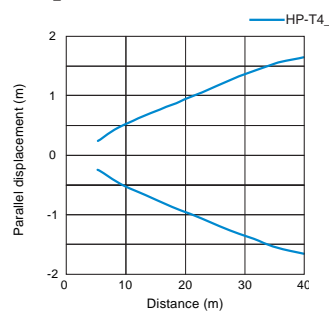

Parallel displacement

HP7-T1_ vertical slit mounted (emitter and receptor)

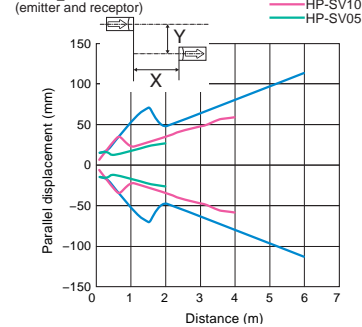

Parallel displacement

HP7-T1_ horizontal slit mounted (emitter and receptor)

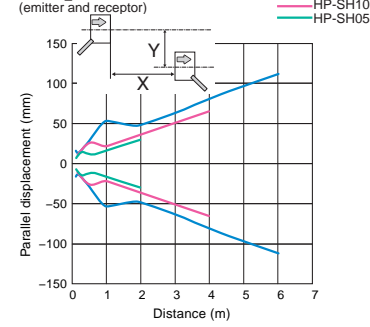

Parallel displacement

HP7-T2_ vertical slit mounted (emitter and receptor)

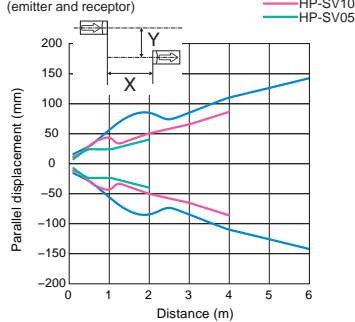

Parallel displacement

HP7-T2_ horizontal slit mounted (emitter and receptor)

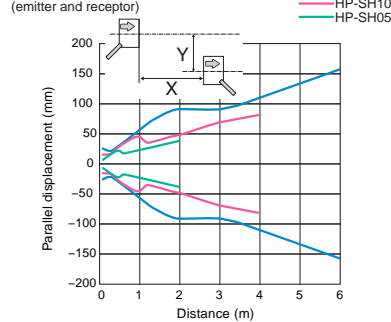

Parallel displacement

HP7-T5_ vertical slit mounted (emitter and receptor)

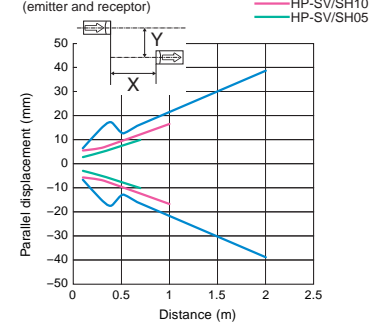

Parallel displacement

HP7-T5_ horizontal slit mounted (emitter and receptor)

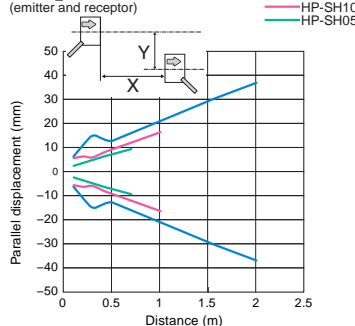

Parallel displacement

HP7-T1_ With mutual interference protection filter

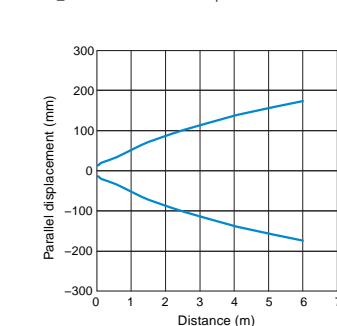

Parallel displacement

HP7-T5_ With mutual interference protection filter

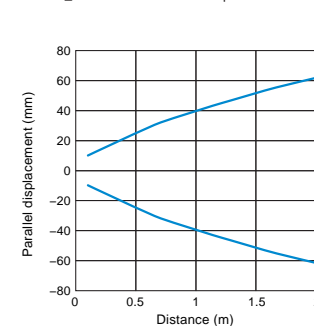

*The above summary of key characteristics should not be construed as a performance guarantee. Always test first under actual conditions and allow leeway as appropriate.

Retroreflective models (HP7-P1_)

Excess gain
(light received over the required amount)

— FE-RR8/FE-RR21
— FE-RR22
— FE-RR15/FE-RR18
— FE-RR20

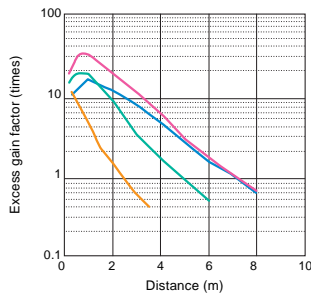

Parallel displacement

— FE-RR8/FE-RR22
— FE-RR15/FE-RR18
— FE-RR21 horizontal
— FE-RR21 vertical
— FE-RR20 horizontal
— FE-RR20 vertical

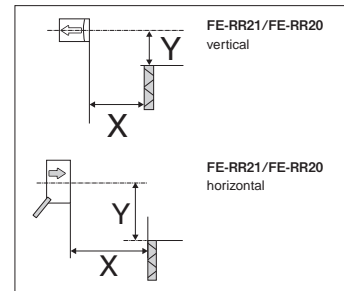
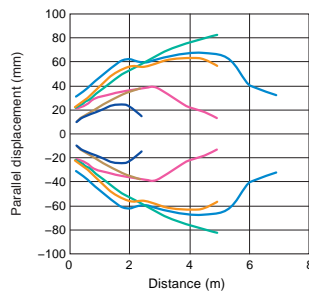

Diffuse-scan models(HP7-A1_/A4_)

Excess gain
(light received over the required amount)

— HP7-A1_
— HP7-A4_

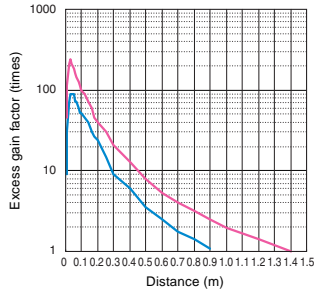

Detection area characteristics

— HP7-A1_
— HP7-A4_

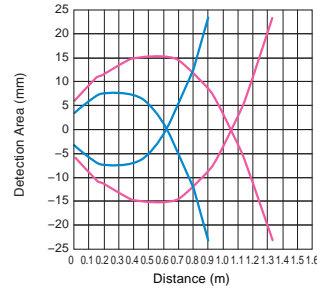

Target specifications

HP7-A1_

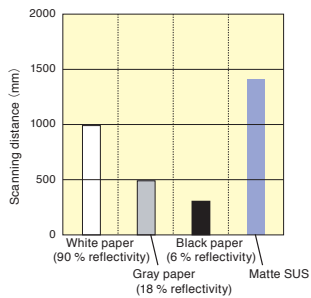

When used with highly reflective backgrounds, tilting the sensor may improve background suppression.

Target specifications

HP7-A4_

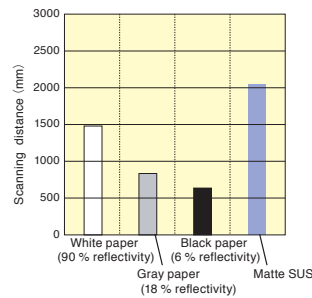

When used with highly reflective backgrounds, tilting the sensor may improve background suppression.

Background interference during tuning
(no workpiece) (background = matte SUS)

— White paper
— Black paper
— Matte SUS

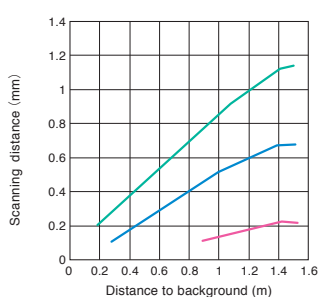

Background interference during tuning
(no workpiece) (background = matte SUS)

— White paper
— Black paper
— Matte SUS

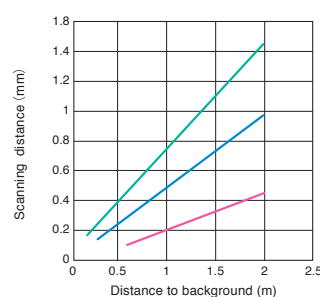

How to interpret the table

Example: Tuning (without a workpiece) of model HP7-A1_ against a matte SUS background at 1 m where white paper target is detected at distances of up to approx. 0.5 m.

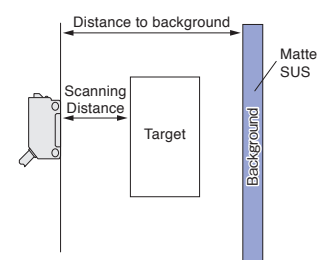

* All graphs represent typical data but not warranted specification. Use the sensor with appropriate margin.

External Dimensions (Unit: mm)

Retroreflective/Diffuse-scan

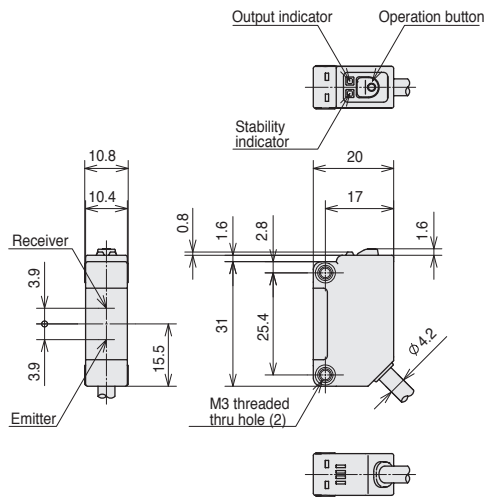

Thru-scan emitter

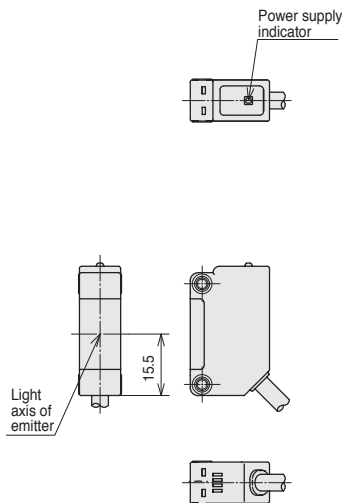

Thru-scan receiver

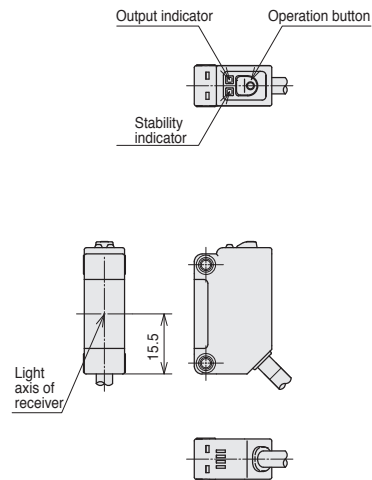

Connector part

HP7-___-C___
(M12 prelead connector)

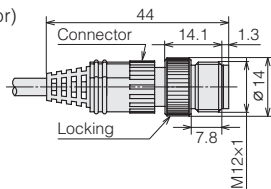

HP7-___-S___
(Quick Lock prelead connector)

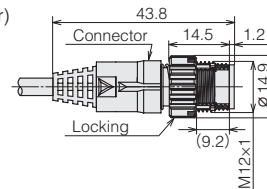

Slit

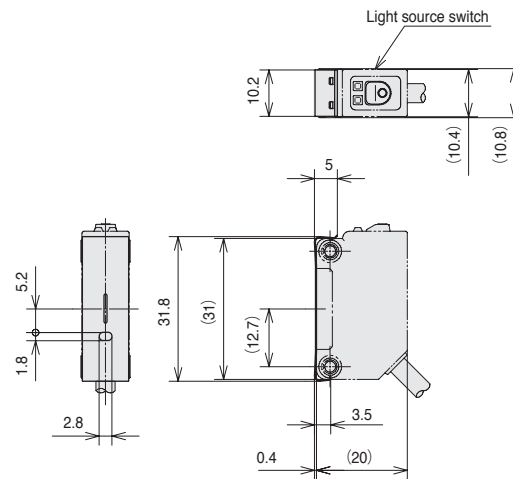
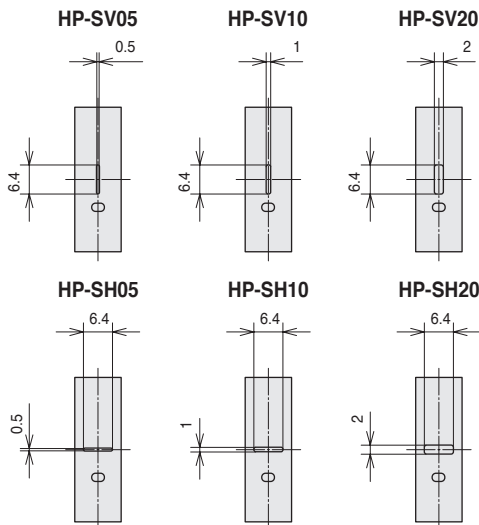

Filter

Polarizing direction:
vertical

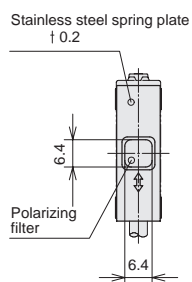

Polarizing direction:
horizontal

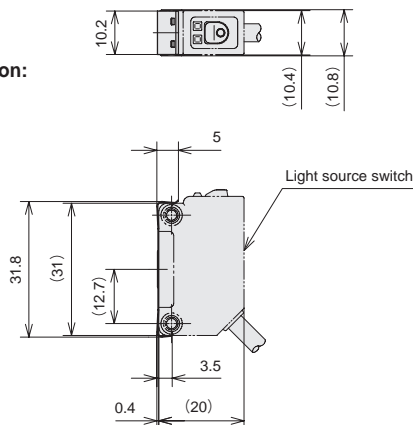
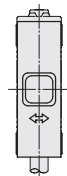

Scanning distance with slit on thru-scan model

Catalog listing of a model used with			
		HP7-T1_ HP7-T2_	HP7-T5_
Slit width	Type	Scanning distance	Scanning distance
0.5x6.4mm	HP-S_05	1.2m	0.4m
1.0x6.4mm	HP-S_10	3m	0.7m
2.0x6.4mm	HP-S_20	5m	1.5m

Scanning distance when mutual interference protection filter is mounted on thru-scan model

Catalog listing of a model used with		
Catalog listings	HP7-T1_	HP7-T5_
HP-U02	7m	1.8m

Bracket (sold separately)

Button-mounting L-bracket (HP-B08)

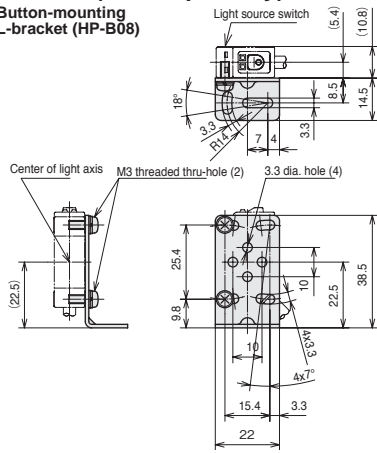

Button-mounting L-bracket (HP-B09)

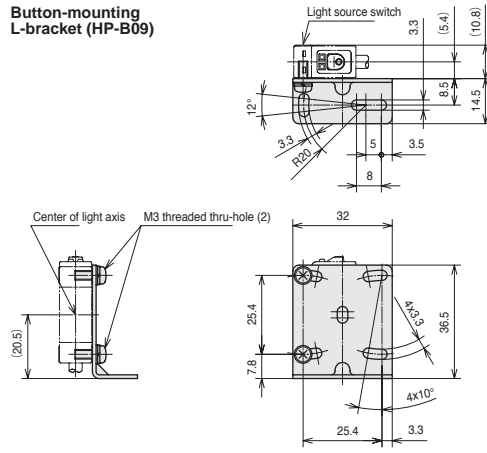

Rear-mounting L-bracket (HP-B10)

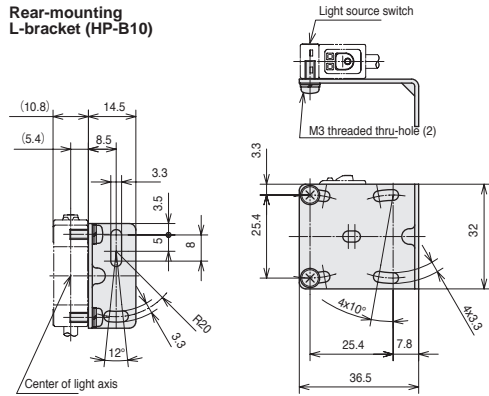

Wraparound vertical mounting bracket (HP-B11)

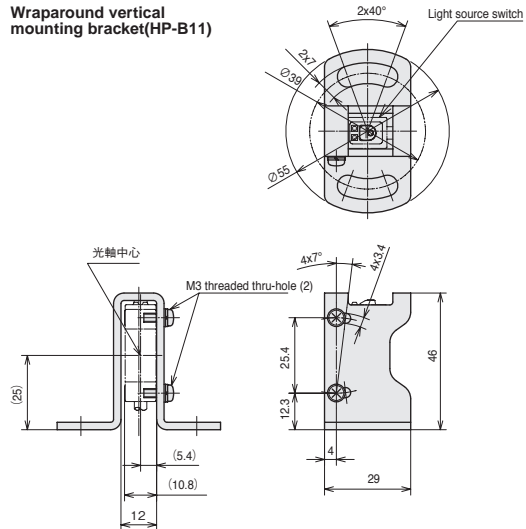

Wraparound horizontal mounting bracket (HP-B12)

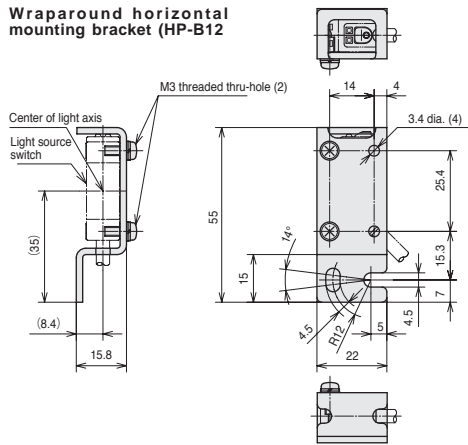

Reflector (sold separately)

FE-RR8

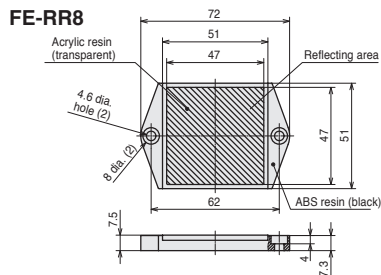

FE-RR15

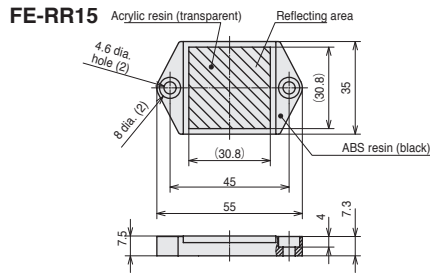

FE-RR18

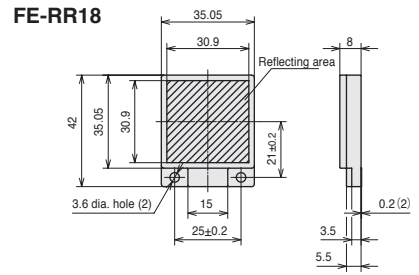

FE-RR20

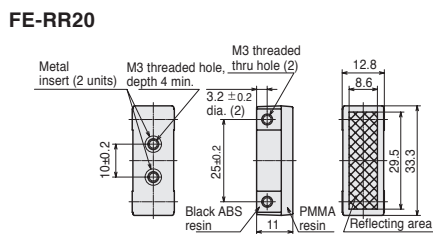

FE-RR21

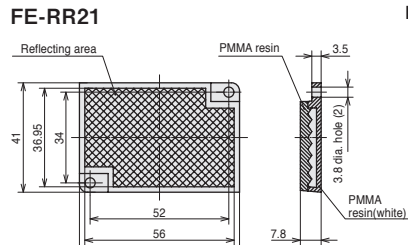

FE-RR22

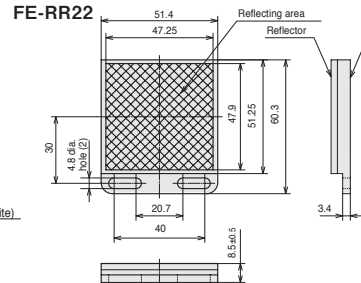

Handling

Warning



- **Designed for general industrial use, not for safety equipment.**
- **Do not connect this device to AC power. Doing so might cause rupture or burnout.**

Handling precautions

- Tighten the mounting screws to a maximum torque of 0.8 N·m.
- Output is disabled upon power-up for 60ms max. until the unit stabilizes.
- For outdoor use, put inside a case, etc., to prevent direct exposure to sunlight and rain water.
- Avoid locations with strong vibration or impact. They may cause optical axis misalignment.
- Shield the lens from water and oil. Water or oil on the lens can cause faulty operation.
- Do not expose to chemicals (organic solvents, acids, alkalis).
- Use a cover or change the mounting direction to ensure correct sensor operation if there is heavy interference from ambient light.
- When used in a very dusty environment, be sure to take countermeasures to keep dust away from the lens surface by using a sealed case or air purging.
- Even when oil-resistant cord is used, do not use in a location subject to continuous splashing by water or oil, or where the unit is immersed in liquid. Ensure that the end of the cord is not subject to splashing by water or oil.
- A bend in the cord immediately after it exits the device should have a radius of at least 30 mm. Also, avoid use in which the cord receives repeated bending stress.
- Do not pull the cord with excessive force (≥ 50 N). Cord disconnection can cause burnout.
- Photoelectric sensors are assembled with precision. Never strike with another object.
Especially if the lens surface is scratched or cracked, sensor performance may decline.
Handle with care.
- To clean the lens or reflector, wipe lightly with a soft, clean cloth or cloth moistened with water. Do not use an organic solvent such as alcohol, benzene, acetone, or thinner.
- When multiple photoelectric sensors are used close together, mutual interference may occur. After installation, check the operation carefully before use.
- Standard cord might get hardened under 0°C. Do not bend or apply shock / vibration under 0°C. Low temperature cord is available.
- Sensor might not reliably detect highly reflective objects or objects that disrupt polarization (ex.: object covered with transparent film). In such a case try the following countermeasures:
Sample countermeasures
 - Mount the sensor at an angle to the target object.
 - Increase the distance between the sensor and the target object.
 - Tune the sensor without a workpiece.

Wiring precautions

- If a cord extension is necessary, use wire at least 0.3 mm² in cross-sectional area and at most 100 m long.
- If the cord of photoelectric sensor are laid in the same conduit as high-voltage or power lines, inductance may cause malfunction or damage. Isolate the photoelectric sensor's cord or lay it in a separate conduit.
- When using a commercially available switching regulator, ground the frame ground and ground terminals. If used without grounding, switching noise may cause faulty operation.
- When using a load which generates an inrush current above the switching capacity, such as a capacitive load or incandescent lamp, connect a current-limiting resistor between the load and the output terminals. Otherwise, the output short-circuit protection function may be activated.

Adjustment method

- Thru-scan model and retroreflective model
 1. Move the emitter and receiver (main body and reflector in case of a retroreflective model) up, down, right, and left, and then align them in the center of the area where the green stable-operation indicator lights up.
 2. Check sensor operation using a target object then use the Auto Adjust button to adjust the sensitivity setting.
- Diffuse-scan model
 1. Mount the photoelectric sensor pointing toward the desired detection position.
 2. Check sensor operation using a target object then use the Auto Adjust button to adjust the sensitivity setting.

The operation method

LO/DO Changeover

The operating mode is set to default at the factory, but can be changed as outlined below. Light-operate changes to Dark-operate, and Dark-operate changes to Light-operate.

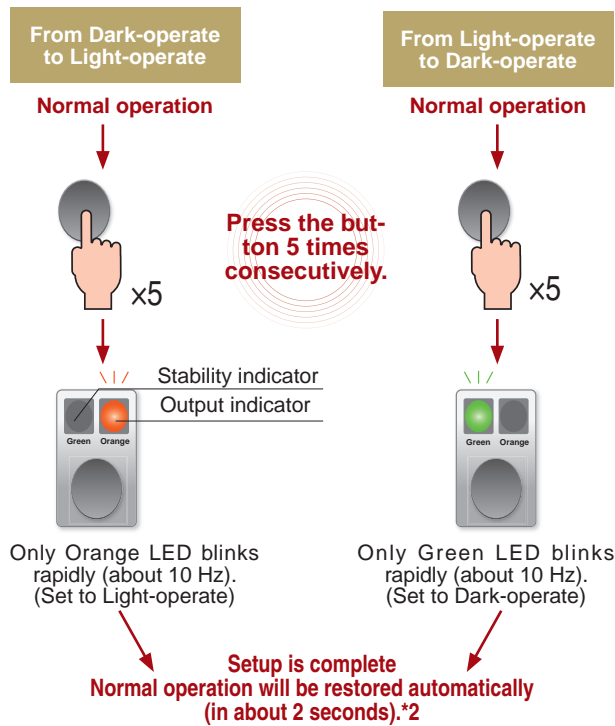

2-point tuning

2-point tuning is used in situations when tuning without a workpiece does not provide a stable detection. Two-point tuning automatically sets the light sensitivity to a value mid-way between the state when the target is present and when the target is absent.

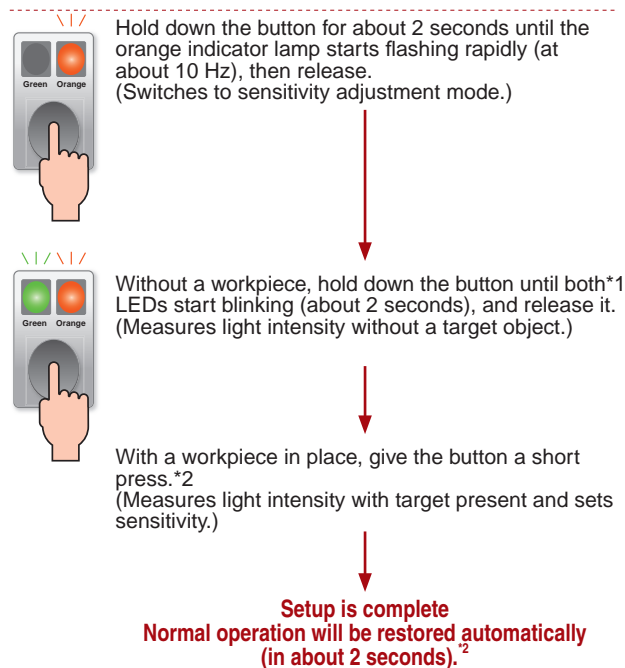

*1. It is OK to reverse the order of the two states (target present/target absent).

*2. If the indicator lamp flashes repeatedly, repeat the procedure as described under Indicator lamp flashes repeatedly

Tuning without a workpiece

The factory default setting is maximum sensitivity. If the target is not detected consistently at this setting, adjust the sensitivity using the Auto Adjust button as described below.

(1) Thru-scan models

If the target is translucent or has holes or openings that light can pass through, or if indirect sensor beam presents, the target object may not be able to block the sensor beam properly. By following the set up below, the sensitivity is automatically adjusted to trigger the sensor at approximately half the intensity of the light received when there is no target object present.

For thru-scan models, the light intensity may be too strong at the short distances noted below. This may cause the indicator lamp to flash repeatedly, as described under Indicator lamp flashes repeatedly.

HP7-T1_ _ _ , HP7-T2_ _ _ : 1 m HP7-T5_ _ _ : 0.3 m

(2) Retroreflective models

If the target is translucent or has holes or openings that light can pass through, or if indirect sensor beam presents, the target object may not be able to block the sensor beam properly. By following the set up below, the sensitivity is automatically adjusted to trigger the sensor at approximately half the intensity of the light received when there is no target object present.

(3) Diffuse-scan models

Use Auto Adjust button in situations where reflection from background is too strong to detect a target. The sensitivity is automatically adjusted to trigger the sensor at approximately twice the intensity of the light received when there is no target object present.



Hold down the button for about 2 seconds until the orange indicator lamp starts flashing rapidly (at about 10 Hz), then release. (Switches to sensitivity adjustment mode.)

Without a workpiece, give the button a short press. Both LEDs turn OFF. (Measures the light intensity without a target object and sets sensitivity as required.)

Setup is complete
Normal operation will be restored automatically.*3 (in about 2 seconds).

*3. If the indicator lamp flashes repeatedly, repeat the procedure as described under Indicator lamp flashes repeatedly.

Position tuning

Position tuning is the procedure for configuring a diffuse-scan sensor to detect a target at a specific position. Position tuning has a maximum 15 % tolerance.

Applicable distance range:

HP7-A1_:_:200–500 mm, HP7-A4_:_: 200–1,000 mm

 Hold down the button for about 2 seconds until the orange indicator lamp starts flashing rapidly (at about 10 Hz), then release. (Switches to sensitivity adjustment mode.)

 With the target in position, hold down the button for about 2 seconds until both indicator lamps start flashing rapidly (at about 10 Hz), then release.

 Now press the button again briefly. Both indicator lamps will flash slowly (at about 1 Hz).^{*4}

Press the button briefly.

Setup is complete
Normal operation will be restored automatically (in about 2 seconds).

^{*4}. If the orange light continues to flash slowly (at about 1 Hz), repeat the procedure as described under Indicator lamp flashes repeatedly.

Checking LO/DO

Use the procedure shown below to check the current operating mode.

Normal operation

Press the button 3 times consecutively.

 Orange LED only blinks rapidly (about 10 Hz). (Indicates Light-operate status.)

Reverts to normal Indication.
(in about 2 seconds)

 Green LED only blinks rapidly (about 10 Hz). (Indicates Dark-operate status.)

Reverts to normal Indication.
(in about 2 seconds)

When confused, or to restore the default setting (max. sensitivity)





The factory default setting is maximum sensitivity. This procedure is used to restore the factory default setting, which may be useful for resolving confusion during the setting procedure. This procedure will restore sensitivity to the factory default setting from any state (irrespective of how the indicator is flashing).

 Hold down the button until the green LED starts blinking (about 7 seconds). (Sensitivity is restored to the factory default setting.)

Setup is complete
Normal operation will be restored automatically (in about 2 seconds).

Indicator lamp flashes repeatedly

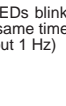
The table below lists the various states indicated by repeated flashing together with suggested responses. If the problem is not resolved, it may be necessary to try a different model of sensor.

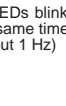
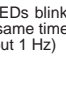
LED indicators	Status	Solution
 Orange indicator flashes rapidly or both indicators flash rapidly (at about 10 Hz)	Tuning in progress	Hold down the button until the green indicator flashes rapidly (about 7 seconds) to restore the factory default setting (maximum sensitivity).
 Orange LED only blinks slowly. (at about 1 Hz)	Tuning Without a tuning workpiece Tuning failed - insufficient light	Thru-scan and retroreflective models Press the button once to revert to normal operation at the pre-tuning sensitivity. Adjust the light axis and then repeat the tuning procedure.
 Both LEDs blink slowly at the same time. (at about 1 Hz)	2-point tuning Tuning failed - insufficient light at both points	Press the button once to revert to normal operation at the pre-tuning sensitivity. Thru-scan and retroreflective models Adjust the light axis and then repeat the tuning procedure. Diffuse-scan models Move the sensor closer to the target to boost the reflected light intensity and then repeat the tuning procedure.
 Both LEDs blink slowly at the same time. (at about 1 Hz)	2-point tuning Tuning failed - too much light at both points	Thru-scan models Press the button once to revert to normal operation at the pre-tuning sensitivity. Reduce the amount of light by using slits or tilting the optical axis, and then repeat the tuning procedure.
 Both LEDs blink slowly at the same time. (at about 1 Hz)	Tuning without workpiece Setup is done but light intensity is too high. Stability Indicator may not light up.	Press the button once to revert to normal operation based on the tuning results. Use a workpiece to verify that the sensor works properly. Thru-scan models Reduce the amount of light by mounting slits or tilting the optical axis, and then repeat the tuning procedure. Diffuse-scan models Minimize the reflected light by painting the background black, and then repeat the tuning procedure.
 Both LEDs blink slowly at the same time. (at about 1 Hz)	Tuning without workpiece Setup is done but too low. Stability Indicator may not light up.	Thru-scan and retroreflective models Press the button once to revert to normal operation based on the tuning results. Adjust the light axis and then repeat the tuning procedure.
 Both LEDs blink slowly at the same time. (at about 1 Hz)	2-point tuning Setup is done but Stability indicator may not light up (Not enough difference in light intensity between the two points).	Thru-scan, retroreflective, and diffuse-scan models Press the button once to revert to normal operation based on the tuning results. Check operation before use.

Cable with connector

PA5 Series cable

Be sure to use a PA5 Series cable with connector when connecting a preleaded connector or connector-type sensor.

● PA5 Series cable with connector

Shape	Power supply	Cable properties	Cable length	Catalog listing	Lead colors
	DC	Vinyl-insulated cable with high resistance to oil and vibration (UL/NFPA79 CM, CL3)	2 m	PA5-4I SX2SK	1: brown, 2: white, 3: blue, 4: black
			5 m	PA5-4I SX5SK	1: brown, 2: white, 3: blue, 4: black
			2 m	PA5-4I LX2SK	1: brown, 2: white, 3: blue, 4: black
			5 m	PA5-4I LX5SK	1: brown, 2: white, 3: blue, 4: black

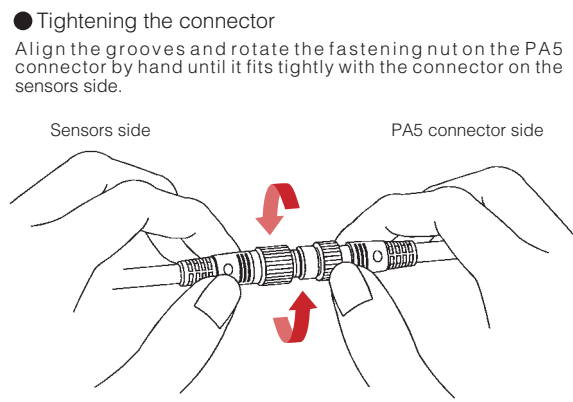
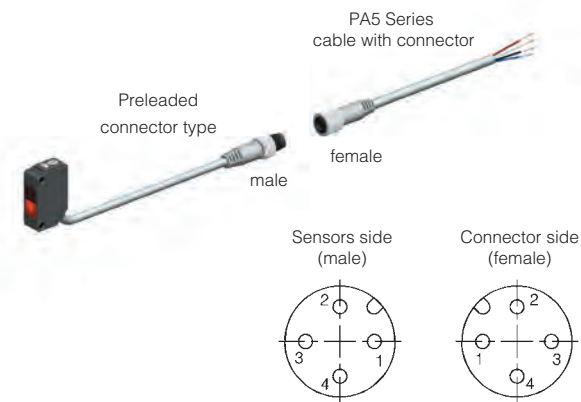

PA7 Series cable

Be sure to use a PA7 Series cable with connector when connecting Quick Lock type sensor.

● PA7 Series cable with connector

Shape	Power supply	Cable properties	Cable length	Catalog listing	Lead colors
	DC	Vinyl-insulated cable with high resistance to oil and vibration (UL/NFPA79 CM)	2 m	PA7-4I SX2SK	1: brown, 2: white, 3: blue, 4: black
			5 m	PA7-4I SX5SK	1: brown, 2: white, 3: blue, 4: black

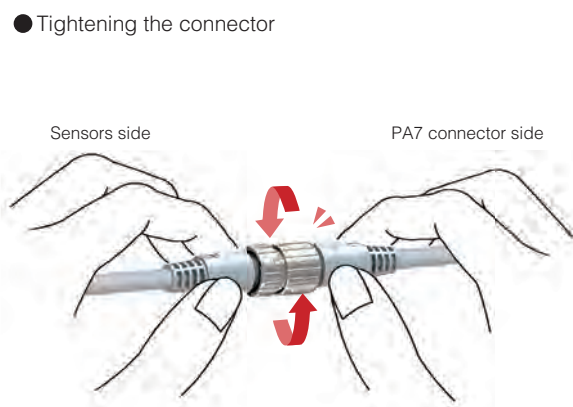
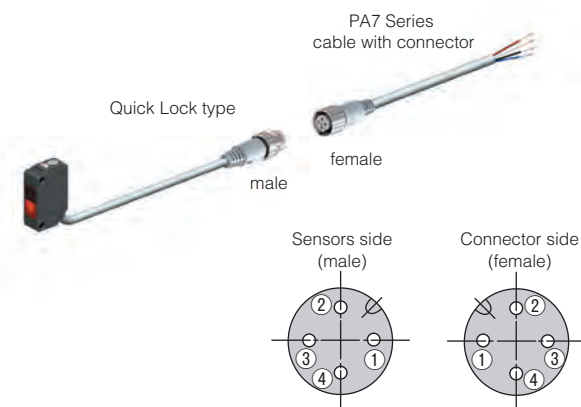

Align the triangle mark and mate the male and female connector then rotate 45 degree to match the keys on the rings by hand.

Other products

Digital Fiber – Optic Sensors

High-performance
HPX-AG series



Standard
HPX-EG series



Potentiometer
HPX-A/H series



Analog output
HPX-MA series



Sample applications
An extensive lineup of products to suit any and every application.

Simple present/
absent detection



Meander
detection

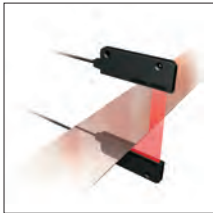

Detection of
front/back



Liquid level
detection

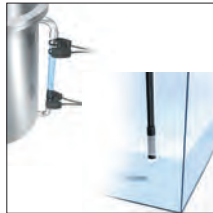

Leak detection



High heat/vacuum
applications

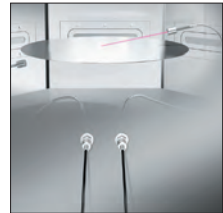

Photoelectric sensors

Compact general-purpose
photoelectric sensor HPJ



Background suppression Type

Fully sealed die-cast zinc body
HP800



Designed for use machining applications

Vane configuration
HPV



For positioning applications

Proximity sensors

General-purpose
proximity sensor
FL7M series



Standard cylinder shapes

Compact proximity
sensors
APM series

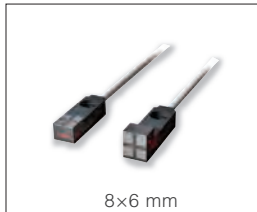

8x6 mm

Compact proximity
sensors
APT series



$\phi 3/3.5 \text{ mm}^2$

Compact proximity
sensors
FL7N/M



$\phi 4/M5 \text{ mm}$

Square proximity
sensor
FL2 series

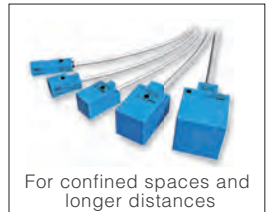

For confined spaces and
longer distances

Mechanical switches

General-purpose limit switches



Standard limit switch

Compact limit switches



Fully sealed, available in various
plunger configurations

Safety limit switches with
positive opening mechanism



Available in a range of housing material, from
low-cost plastic to durable die-cast metals

Please read the "Terms and Conditions" from the following URL before ordering or use:

<http://www.azbil.com/products/bi/order.html>

*[Notice] Specifications are subject to change without notice.
No part of this publication may be reproduced or duplicated
without the prior written permission of Azbil Corporation.*

Other product names, model numbers and company names may be trademarks of the respective company.

Azbil Corporation

Advanced Automation Company

Yamatake Corporation changed its name to Azbil Corporation on April 1, 2012.

1-12-2 Kawana, Fujisawa
Kanagawa 251-8522 Japan

URL: <http://www.azbil.com>

1st Edition : Issued in May. 2012-AZ

CP-PC-2263E